

# CombiSteel

CATERING EQUIPMENT

## Horizontal Showcase Operation instructions



7487.0065



7487.0070



7487.0075

Thank you for purchasing this horizontal show case

Please read these instructions carefully to ensure you get the best results and longest life from your product.

### **Contents**

- 2) General
- 2) Structure and Parts
- 3) Handling and Placement
- 4) Set up and Power
- 5) Usage instructions
- 6) Safety Warnings
- 7) Maintenance and Trouble Shooting
- 8) Refrigeration System and Circuit diagram
- 9) Technical Specifications







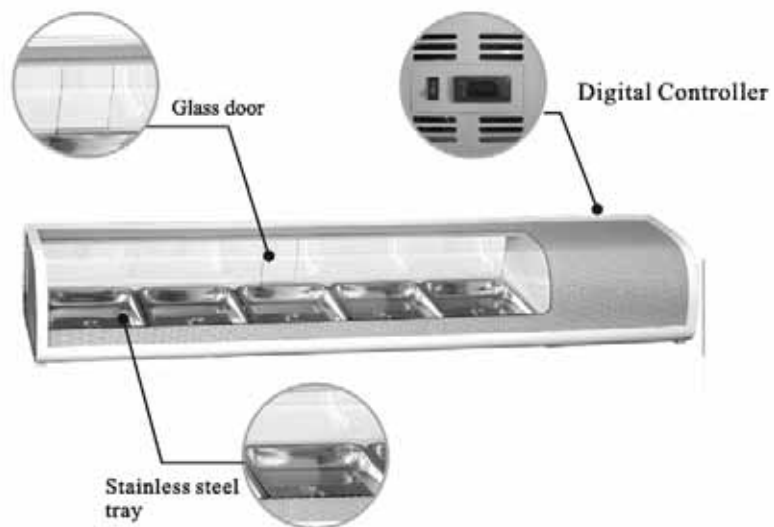

### General

1. A high quality, fully enclosed compressor is used in this product and utilises the R134a Or R600a refrigerant which is an environmentally friendly gas. A forced air refrigeration system is used which ensures that the temperature is very even throughout the case.
2. Glazing is used throughout the product for maximum visibility and two rear mounted sliding doors allow easy access.
3. The horizontal show case has a wide range of uses including convenience stores, bakery outlets and other food service establishments as well as offices and even homes.
4. Always allow a time of around 2 hours between moving the unit and restarting it.

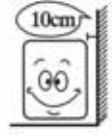

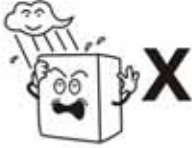

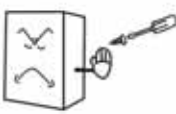

### Structure and Parts

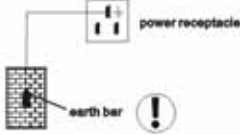

### Handle and Erection

<p><b>Handle with care</b> Unplug the wall socket first. Never tilt it over 45 degree during handling.</p> 	<p><b>Dry place</b> Always locate the refrigerator at a dry place.</p> 
<p><b>Sufficient space</b> The distance from both sides and back of refrigerator to wall or other substance must be less than 10cm. The refrigeration capability might be decreased if its surround space is too small to circulate air.</p> 	<p><b>Well ventilation</b> Always locate the refrigerator at a place with fine ventilation. For the first time use, wait for 2 hours after handling and then plug the wall socket and start it.</p> 
<p><b>Far from heat source</b> Never place the refrigerator directly under the sunshine. Never locate it nearby any heat source or heater to prevent it from reducing refrigeration capability.</p> 	<p><b>No heavy load</b> Never put any heavy load on the top of the refrigerator.</p> 
<p><b>No hole making</b> Never make hole on the refrigerator. Never install other matter on the refrigerator.</p> 	<p><b>Stable location</b> Unpacking and locate the refrigerator on a flat and solid place.</p> 

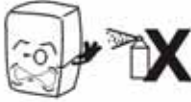
## Set up and Power

<p><b>Power Requirements</b> The unit requires a power supply of 220-240V . It should only be plugged in to a single, plug socket of its own.</p> 	<p><b>Common Sockets</b> Never use a multiple plug extension lead for this product</p> 
<p><b>Protect the cables</b> Never break, damage, cut or otherwise modify the power cables as this can lead to fire and electrocution</p> 	<p><b>Keep away from Water</b> Never flush the refrigerator with water, only use a clean, damp cloth to wipe it down.</p> 
<p><b>Flammables and explosives</b> Keep all flammable and explosive substances away from the fridge as the heat generated by the compressor could cause a fire.</p> 	<p><b>Flammable Spray</b> Never spray or clean the unit with a flammable spray.</p> 
<p><b>Power Cut</b> After a power cut or unit shut down please allow at least 4 minutes before plugging in the unit and re-starting it again.</p> 	<p><b>Not Suitable for Medicine</b> This refrigerator is not suitable for the storage of medicinal products.</p> 

## Usage Instructions

### 1. Before use:

Plug the fridge in to an exclusive 220-240V~ socket

Once the fridge has been running place your hand on the air extractor to confirm that it is sufficiently cold once you are happy then you may put food inside.

### 2. Digital temperature controller:

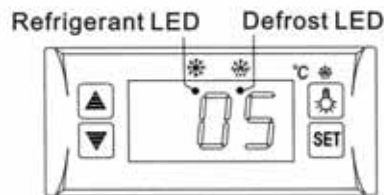

#### Features Of Function

- It is a mini-sized and integrated intelligent controller and applicable to the compressor of one Hp.
- The main functions are: Temperature Display/Temperature control/Manual, automatic defrost by burning off/Illumination Control/Value Storing/self Testing/parameter Locking.

#### Front Panel Operation

##### 1. Set temperature

Press **SET** button, the set temperature is displayed.

Press **▲** or **▼** button to modify and store the displayed value,

Press **SET** button to exit the adjustment and display the cold-room temperature.

##### 2. If no more button is pressed within 10 seconds, the cold-room temperature will be displayed.

##### 3. Illumination: Press **☀** button, it lights; Press again, it stops.

Manual start/stop defrost: Press **☀** button and hold for 6 seconds to defrost or stop defrost.

##### 4. Refrigerant LED: During refrigeration, the LED is on; When the cold room temp. is constant, the LED is off; During the delay start, the LED flashes.

##### 5. Defrost LED: during defrosting, the LED is on; When it stops defrosting, the LED is off; During the delay display of defrost, the LED flashes.

### **Safety Warnings**

When opening the door try to reduce the length of time that it is open for in order to keep the temperature inside cold.

Do not overload the unit with food as it will affect the cooling ability.

Always cool hot food down to room temperature before placing it in the fridge.

The unit should only be maintained by a professional engineer.

Never touch the compressor as it may be hot and burn you.

If the power cord is damaged it must be replaced by the manufacturer or a professional engineer.

Children should be supervised at all times to ensure they are not hurt by the unit.

This appliance is not intended for use by persons (including children) with reduced physical, sensory or mental capabilities, or lack of experience and knowledge, unless they have been given supervision or instruction concerning use of the appliance by a person responsible for their safety.

Children should be supervised to ensure that they do not play with the appliance

The operation manual are not suitable for the persons (including children) with reduced physical, sensory or mental capabilities, or lack of experience and knowledge.

**WARNING!** Keep ventilation openings clear of obstruction at all times.

**WARNING!** Do not use mechanical devices or any other means of accelerated defrosting unless recommended by the manufacturer.

**WARNING!** Do not damage or modify the refrigeration circuit.

**WARNING!** Do not use electrical appliances inside the food storage areas unless they are recommended by the manufacturer.

### **Additional Warning**

**CAUTION!** Risk of fire. The height of the triangle in the symbol shall be at least 15mm.



## Maintenance

### 1. Notice

Always unplug the unit before performing any form of maintenance

Clean the fridge regularly using a clean, damp cloth. Do not use cleaning detergents such as soap, acetone or gasoline

### 2. Clean Outside

Dip a soft cloth in a mild detergent (washing up liquid) to clean the outside, and then wipe off with a dry soft cloth.

### 3. Clean Inside

Remove the tray and clean with water

Use a soft, damp cloth to wipe the interior

### 4. Turning off for prolonged periods

Take out all food and unplug the unit from the wall.

Clean both the inside and outside of the fridge thoroughly and open the door to allow it to dry.

Be careful as the glass can easily be broken.

### 5. Replacement of the light

If the LED is damaged it must be replaced by the manufacturer or their service agent.

## Trouble Shooting

Problem	Cause	Remedy
No refrigeration	Is the plug in the socket correctly?	Check the plug
	Is the fuse broken?	Check fuse and replace if needed
	Is there no power from the socket?	Plug another unit into the socket to check if it works
Unsatisfactory Refrigeration	Is it in direct sunlight or near a heat source?	Move away from the heat source
	Is the surrounding area bad for ventilation?	move to an area with improved ventilation
	Does the door close correctly? Is the door left open?	Check the door
	Is the unit too full?	Remove some food
	Is the temperature controller correct	Check the controller
Unit is making irregular noise	The fridge is not sitting level	Move to a flat surface
	The fridge is vibrating off something else	Move the unit so it is not touching anything
	There is a loose part in the refrigerator	Check the interior for loose items
Contact the manufacturer for help if simple trouble shooting does not solve the problems		

## Note

The following occurrences are not problems

The noise of water is heard when the fridge is working, this is a natural occurrence as the coolant is circulating the system.

Condensation may be found on the outside of the fridge. This is not a problem, it is caused by humidity, simply use a cloth to wipe it.



### Principle of Refrigeration System and Electric Circuit Diagram

The principle of compression refrigeration consists of “compression” , “condensation” , “throttling” and “vaporization” . The compression is undertaken by compressor, the condensation is completed by condenser, the throttling valve is executed by capillary and the vaporization is implemented by evaporator. When the coolant is circulating in the closed refrigeration system, the compressor sucks coolant, which has absorbs heat in evaporator, the coolant becomes a high pressure and high temperature gas. In condenser, it dissipates heat in air, while the coolant is re-liquefied and throttled in capillary and then enters into evaporator with low pressure. The liquefied coolant quickly boils and vaporizes into gas when the pressure suddenly drops. Meanwhile, it absorbs heat inside the refrigerator. And the compressor sucks the low pressure and low temperature gaseous coolant, ..... It is circulating in this way up to realization of intended refrigeration.

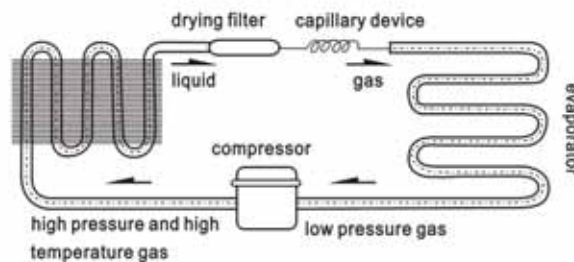

### Circuit Diagram

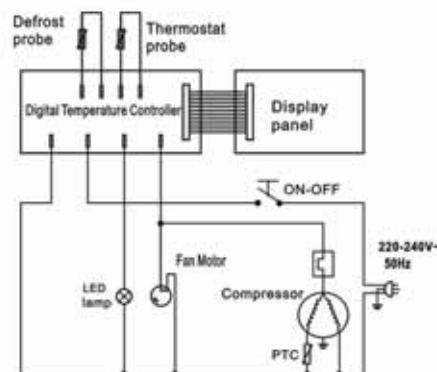

### Major Parameters

Parameter \ Model	7487.0065	7487.0070	7487.0075	
Coolant and injection quantity(g)	R134a(180)			
General Rated input power(W)	160			
Rated current(A)	1.1			
Refrigeration temperature(°C)	0-12			
Electric shock protection class	I			
Type of climate	4			
Lamp power(W)	2(LED)			
Total effective volume(L)	42	52	62	
Net weight(kg)	34.5	38.5	41.5	
Rated voltage(V)	220-240~			
Rated Frequency(Hz)	50			
Overall dimension (mm) (LxWxH)	1177x420x265	1352x420x265	1529x420x265	

#### Note

1. The electric circuit diagram and parameters on the product nameplate are final ones if they have been changed.
2. The design might be improved without notice.



**Meaning of crossed out wheeled dustbin:**

Do not dispose of electrical appliances as unsorted municipal waste, use separate collection facilities.

Contact you local government for information regarding the collection systems available.

If electrical appliances are disposed of in landfills or dumps, hazardous substances can leak into the groundwater and get into the food chain, damaging your health and well-being.

When replacing old appliances with new ones, the retailer is legally obligated to take back your old appliance for disposals at least free of charge.