

SMIN 35
SMIN 45
SMIN 75
SMIN 125

Automatic cubers
Automatic Kegeleisbereiter

TABLE OF CONTENTS	PAGE	INHALTSVERZEICHNIS	SEITE
GENERAL INFORMATION AND INSTALLATION	1	ALLGEMEINES UND INSTALLATION	14
Introduction	1	Einführung	14
Unpacking and inspection	1	Auspacken und Inspektion	14
Location and levelling	1	Maschinenplatz und lotgerechte Austellung	14
Electrical connection	1	Elektrische Anschlüsse	15
Water supply and drain connection	2	Wasserversorgung und Abflußleitungen	15
Final check list	3	Schlußkontrollen	15
Installation practice	3	Installation	16
OPERATING INSTRUCTION	4	BETRIEBSANLEITUNG	17
Start up	4	Inbetriebnahme	17
Operational checks	4	Ueberprüfung im Betrieb	17
OPERATING PRINCIPLES	6	FUNKTIONSSYSTEME	19
Freezing Cycle	6	Gefrierprozess	19
Harvest Cycle	6	Abtauprozess	19
Control sequence	7	Steuersequenzen	20
Electrical sequence	7	Sequenz Elektrische Bestandteile	20
Components description	8	Komponentenbeschrieb	21
Service diagnosis	10	Fonktionsfehler	23
MAINTENANCE AND CLEANING INSTRUCTIONS	12	WARTUNG UND REINIGUNGSANLEITUNG	25
General	12	Woraussetzung	25
Icemaker	12	Reinigung des Eisbereiters	25
Clean - Replace of air condenser filter	12	Reinigung - Austausch des Luftkondensatorfilters	25
Cleaning instructions of water system	12	Wartungs und Reinigungsanleitungen	26

Ice making capacity - Eisproduktionskapazität

SMN 35

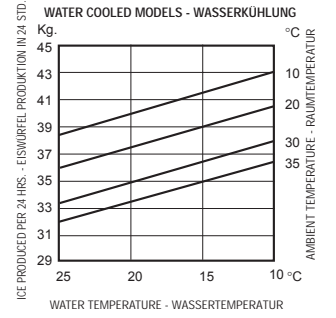
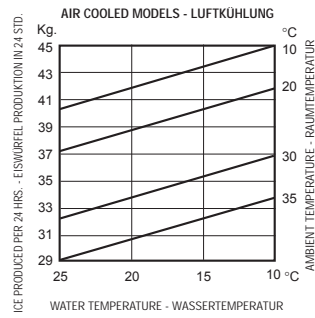

SMN 45

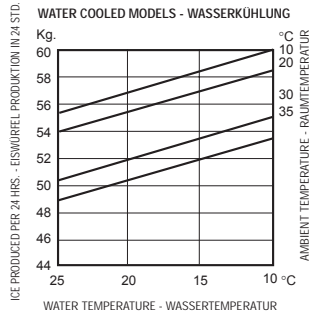
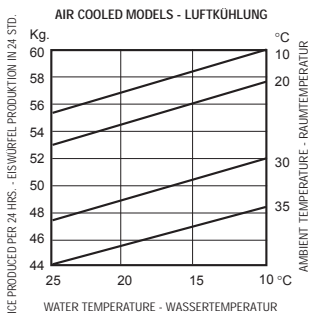

SMN 75

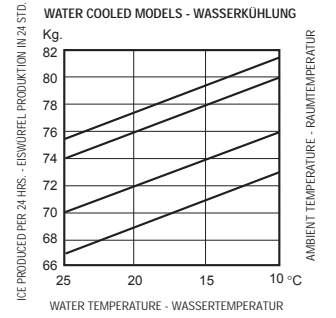
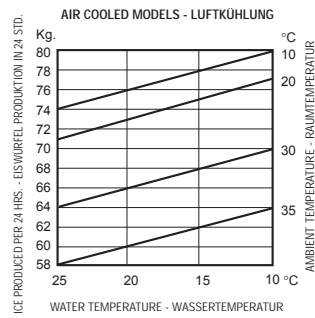

SMN 125

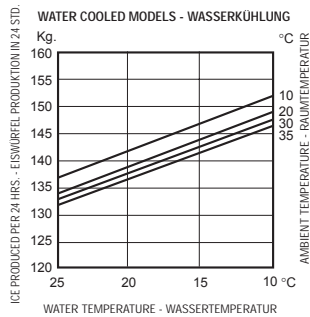
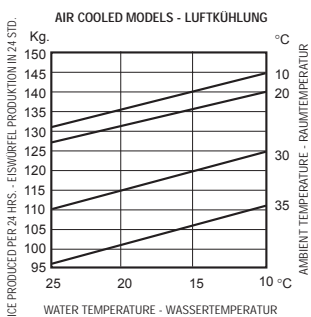

C

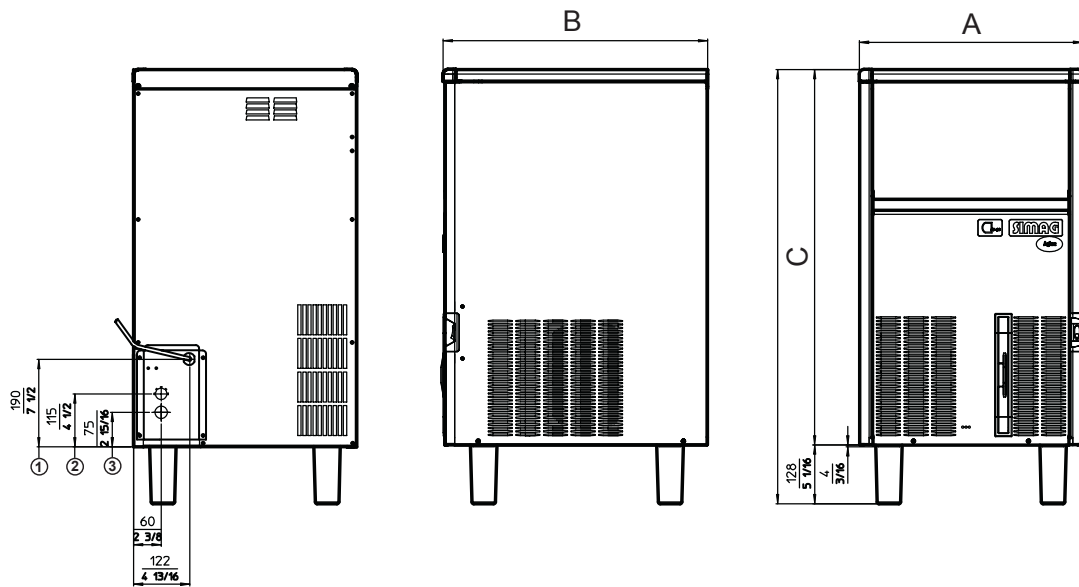

SMN 35 - 45

- ❶ CORD SET - ELEK. KABEL
- ❷ Ø 20 WATER OUTLET - WASSERABFLUSS
- ❸ G3/4" WATER INLET - WASSEREINLAUF

				SMN 35 (mm)	SMN 45 (mm)
A				485	485
B				572	572
C				721	816

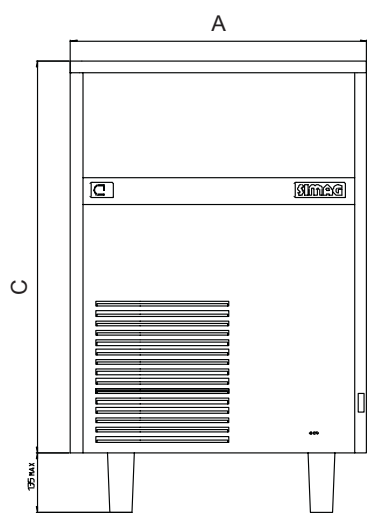
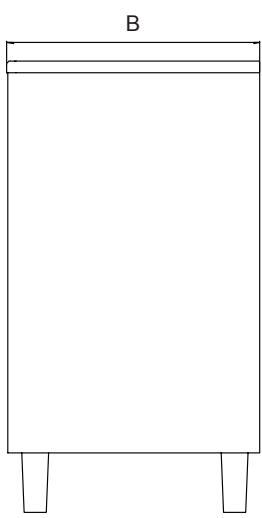
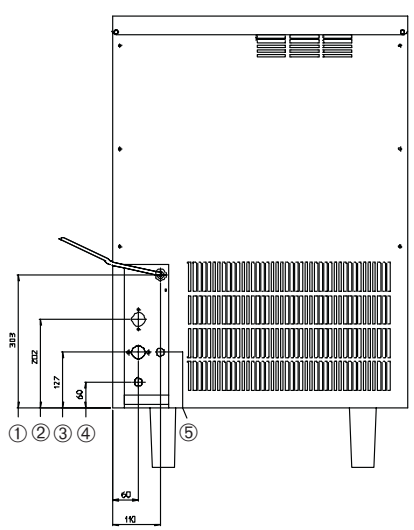

SMN 75

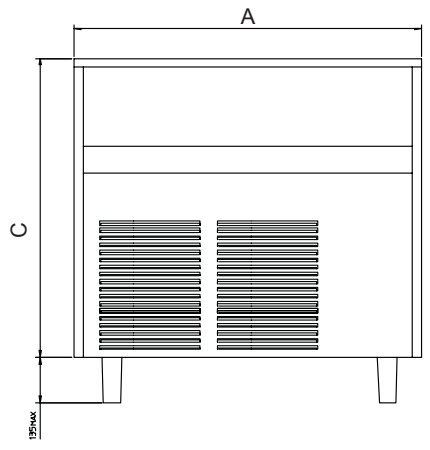
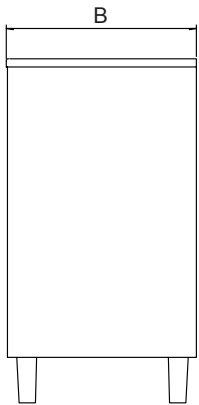
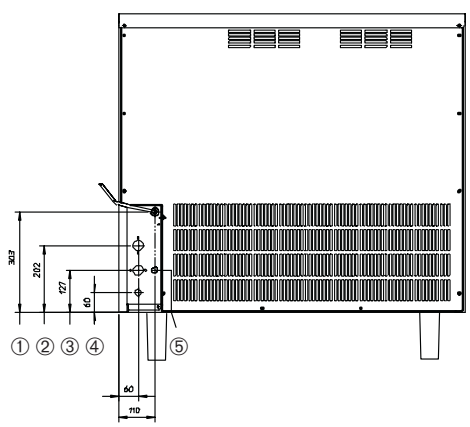

SMN 125

- ❶ CORD SET - ELEK. KABEL
- ❷ Ø 20 WATER OUTLET - WASSERABFLUSS
- ❸ G3/4" WATER INLET - WASSEREINLAUF
- ❹ G3/4" WATER OUTLET - WASSERABFLUSS *
- ❺ G3/4" WATER INLET - WASSEREINLAUF *

* Water cooled only - Nur wassergekühlt

	SMN 75 (mm)	SMN 125 (mm)	
A	670	1045	
B	572	572	
C	890	900	

TECHNICAL SPECIFICATIONS - TECHNISCHE ANGABEN

	SMN35 SMN35W	SMN45 SMN45W	SMN75 SMN75W	SMN125 SMN125W
Electric voltage	230/50/1	230/50/1	230/50/1	230/50/1
Normale Netzspannung	-10÷+10%	-10÷+10%	-10÷+10%	-10÷+10%
Condensation	Air-Water	Air-Water	Air-Water	Air-Water
Kühlung	Luft-Wasser	Luft-Wasser	Luft-Wasser	Luft-Wasser
Bin Capacity (kg)	17	20	30	50
Speiker Kapazität (kg)	17	20	30	50
Net weight (kg)	45	48	61	94
Netto Gewicht (kg)	45	48	61	94
Compressor power HP	1/4	3/8	1/2	1
Kompressorleistung PS	1/4	3/8	1/2	1
Running amps	2.2	3.2	3.8	5.3
Ampere	2.2	3.2	3.8	5.3
Start amps	11	17	20	29
Start ampere	11	17	20	29
Power (Watt)	380	530	650	1200
Leistung (Watts)	380	530	650	1200
Power cons .in 24 hrs (Kwh)	7.5	10.5	13	24
Stromverbrauch in 24 hrs (Kwh)	7.5	10.5	13	24
Wire size (mm')	3 x1	3x1	3x1	3 x 1,5
Kabelanzahl (mm')	3 x1	3x1	3x1	3 x 1,5
Refrig. Charge R134A (gr)	280-240	300-270	450-300	
Kühlmittel full. R134A (gr)	280-240	300-270	450-300	
Refrig. Charge R404A (gr)				630-500
Kühlmittel full. R404A (gr)				630-500
Refrigerant metering device	Capillary tube	Capillary tube	Capillary tube	Capillary tube
Kaltemittel expansionssystem	Kapillarrohr	Kapillarrohr	Kapillarrohr	Kapillarrohr

OPERATING PRESSURES – BETRIEBSDRUCKE

Discharge pressure - Hochdruckbereich				
	SMN 35	SMN 45	SMN 75	SMN 125
Air Cooled (21°C)	8,5÷10 bar	8,5÷10 bar	8,5÷9,5 bar	15÷19,5 bar
Luftgekühlt (21°C)				
Water Cooled	8,5÷10 bar	8,5÷10 bar	9,5 bar	17 bar
Wassergekühlt				
Suction Pressure – Niederdruck Start/End of freezing cycle – Beginn /Ende der Gefrierfase				
	SMN 35	SMN 45	SMN 75	SMN 125
	0,8÷0,1 bar	0,8÷0,1 bar	0,8÷0,1 bar	3,6÷1,5 bar

GENERAL INFORMATION AND INSTALLATION

A. INTRODUCTION

This manual provides the specifications and the step-by-step procedures for the installation, start-up and operation, maintenance and cleaning for the **SIMAG SMN Series** Icemakers.

The **SIMAG SMN** cubers are quality designed, engineered and manufactured.

Their ice making systems are thoroughly tested providing the utmost in flexibility to fit the needs of a particular user.

NOTE. *To retain the safety and performance built into this icemaker, it is important that installation and maintenance be conducted in the manner outlined in this manual.*

B. UNPACKING AND INSPECTION

1. Call your authorized SIMAG Distributor or Dealer for proper installation.
2. Visually inspect the exterior of the packing and skid. Any severe damage noted should be reported to the delivering carrier and a concealed damage claim form filled in subject to inspection of the contents with the carrier's representative present.
3.
 - a) Cut and remove the plastic strip securing the carton box to the skid.
 - b) Remove the packing nails securing the carton box to the skid.
 - c) Cut open the top of the carton and remove the polystyrene protection sheet.
 - d) Pull out the polystyrene posts from the corners and then remove the carton.
4. Remove the front and the rear panels of the unit and inspect for any concealed damage. Notify carrier of your claim for the concealed damage as stated in step 2 above.
5. Remove all internal support packing and masking tape.
6. Check that refrigerant lines do not rub against or touch other lines or surfaces, and that the fan blades move freely.
7. Check that the compressor fits snugly onto all its mounting pads.
8. See data plate on the rear side of the unit and check that local main voltage corresponds with the voltage specified on it.

CAUTION. *Incorrect voltage supplied to the icemaker will void your parts replacement program.*

9. Remove the manufacturer's registration card from the inside of the User Manual and fill in all parts including: Model and Serial Number taken from the data plate.

Forward the completed self-addressed registration card to SIMAG factory.

C. LOCATION AND LEVELLING

WARNING. *This Ice Maker is designed for indoor installation only. Extended periods of operation at temperature exceeding the following limitations will constitute misuse under the terms of the SIMAG Manufacturer's Limited Warranty resulting in LOSS of warranty coverage.*

1. Position the machine bin in the selected permanent location and tighten the four legs (SMN 35 - 45 - 75 - 125). Criteria for selection of location include:
 - a) Minimum room temperature 10°C (50°F) and maximum room temperature 40°C (100°F).
 - b) Water inlet temperatures: minimum 5°C (40°F) and maximum 40°C (100°F).
 - c) Well ventilated location for air cooled models (clean the air cooled condenser at frequent intervals).
 - d) Service access: adequate space must be left for all service connections through the rear of the ice maker. A minimum clearance of 15 cm (6") must be left at the sides of the unit for routing cooling air drawn into and exhausted out of the compartment to maintain proper condensing operation of air cooled models.

NOTE. *With the unit in "built-in" conditions, the ice production is gradually reduced in respect to the levels shown in the graph, up to a maximum of 10% at room temperatures higher than 32°C.*

*The daily ice-making capacity is directly related to the condenser air inlet temperature, water temperature and age of the machine. To keep your **SIMAG CUBER** at peak performance levels, periodic maintenance checks must be carried out as indicated on this manual.*

2. Level the Icemaker in both the left to right and front to rear directions by means of the adjustable legs.

D. ELECTRICAL CONNECTIONS

See data plate for current requirements to determine wire size to be used for electrical connections. All SIMAG icemakers require a solid earth wire.

All SIMAG ice machines are supplied from the factory completely pre-wired and require only electrical power connections to the wire cord provided at the rear of the unit.

Make sure that the ice machine is connected to its own circuit and individually fused (see data plate for fuse size). The maximum allowable voltage variation should not exceed -10% and +10% of the data plate rating. Low voltage can cause faulty functioning and may be responsible for serious damage to the overload switch and motor windings.

NOTE. All external wiring should conform to national, state and local standards and regulations.

Check voltage on the line and the ice maker's data plate before connecting the unit.

E. WATER SUPPLY AND DRAIN CONNECTIONS

GENERAL

When choosing the water supply for the cuber consideration should be given to:

- a) Length of run
- b) Water clarity and purity
- c) Adequate water supply pressure

Since water is the most important single ingredient in producing ice you cannot emphasize too much the three items listed above.

Low water pressure, below 1 bar may cause malfunction of the ice maker unit.

Water containing excessive minerals will tend to produce cloudy colored ice cubes, plus scale build-up on the interior parts of the water system.

WATER SUPPLY

Connect the 3/4" GAS male of the water inlet fitting, using the food grade flexible tubing supplied with the machine, to the cold water supply line with regular plumbing fitting and a shut-off valve

installed in an accessible position between the water supply line and the unit.

If water contains a high level of impurities, it is advisable to consider the installation of an appropriate water filter or conditioner.

WATER SUPPLY - WATER COOLED MODELS (SMN 75-125)

The water cooled versions of SIMAG Ice Makers require two separate inlet water supplies, one for the water making the ice and the other for the water cooled condenser.

Connect the 3/4" GAS male fitting of the water inlet, using the flexible tubing supplied with the unit, to the cold water supply line with regular plumbing fitting and a shut-off valve installed in an accessible position between the water supply line and the unit.

WATER DRAIN

Connect the drain fitting with a plastic tube to an open trapped and vented drain. When the drain is a long run, allow 3 cm pitch per meter (1/4" pitch per foot).

On water cooled versions, the water drain line from the condenser is internally connected with the drain fitting of the unit.

It is strongly recommended therefore to install a vertical open vent on unit drain line high point to ensure good draining and to direct the drain line to a trapped and vented floor drain receptacle.

NOTE. The water supply and the water drain must be installed to conform with the local code. In some case a licensed plumber and/or a plumbing permit is required.

F. FINAL CHECK LIST

1. Is the unit in a room where ambient temperatures are within a minimum of 10 °C (50°F) even in winter months?
2. Is there at least a 15 cm (6") clearance around the unit for proper air circulation?
3. Is the unit level? (IMPORTANT)
4. Have all the electrical and plumbing connections been made, and is the water supply shut-off valve open?
5. Has the voltage been tested and checked against the data plate rating?
6. Has the water supply pressure been checked to ensure a water pressure of at least 1 bar (14 psi)? Open the shut-off valve and verify the absence of water losses from the connections.

7. Have the bolts holding the compressor down been checked to ensure that the compressor is snugly fitted onto the mounting pads?
8. Check all refrigerant lines and conduit lines to guard against vibrations and possible failure.
9. Have the bin liner and cabinet been wiped clean?
10. Has the owner/user been given the User Manual and been instructed on the importance of periodic maintenance checks?
11. Has the Manufacturer's registration card been filled in properly? Check for correct model and serial number against the serial plate and mail the registration card to the factory.
12. Has the owner been given the name and the phone number of the authorized SIMAG Service Agency serving him?

G. INSTALLATION PRACTICE

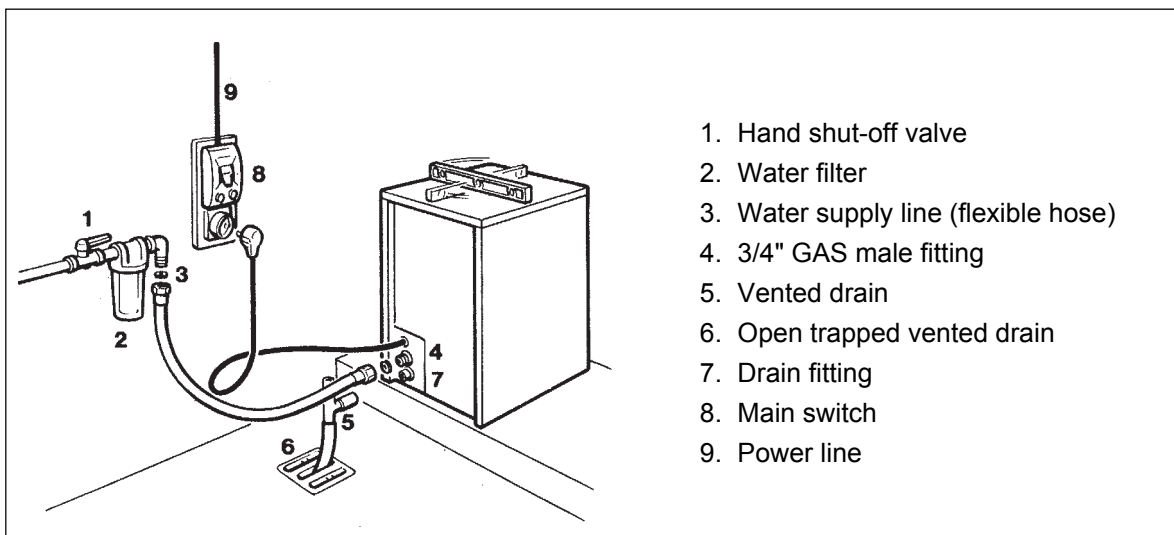

1. Hand shut-off valve
2. Water filter
3. Water supply line (flexible hose)
4. 3/4" GAS male fitting
5. Vented drain
6. Open trapped vented drain
7. Drain fitting
8. Main switch
9. Power line

WARNING. This icemaker is not designed for outdoor installation and will not function in ambient temperatures below 10°C (50°F) or above 40°C (100°F). This icemaker will malfunction with water temperatures below 5 °C (40°F) or above 40 °C (100°F).

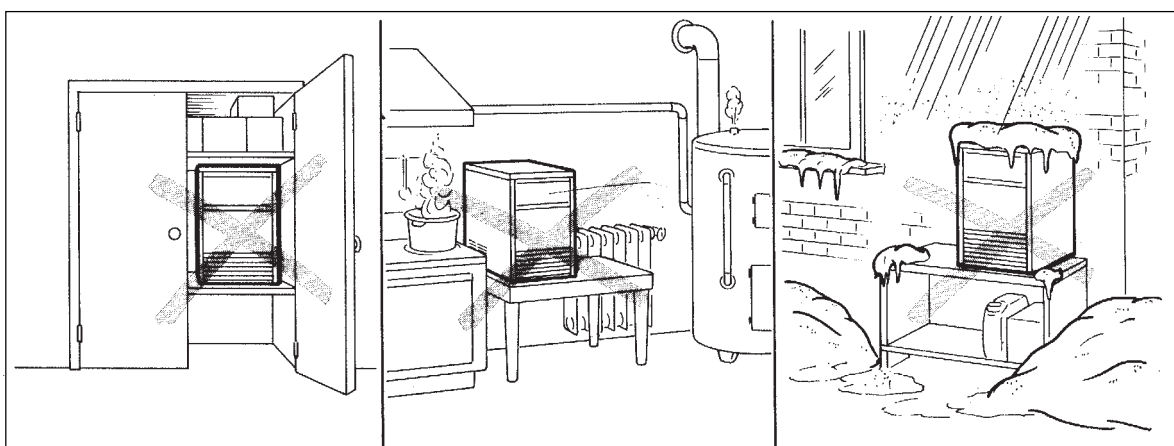

OPERATING INSTRUCTIONS

START UP

After having correctly installed the ice maker and completed the plumbing and electrical connections, perform the following “Start-up” procedure.

A. Put the icemaker in operation by moving the unit master switch, located on the cabinet front, to the ON position.

NOTE. The icemaker control is factory set with the timer microswitches actuators dropped off into the initial point of the cam slot. This setting position allows a proper water filling.

The unit starts operating in the “defrost cycle” with the following components being activated:

- THE WATER INLET SOLENOID VALVE**
- THE HOT GAS SOLENOID VALVE**
- THE CONTACTOR COIL (SMN 75-125)**
- THE FAN MOTOR (only SMN 35) air cooled**
- THE COMPRESSOR**
- THE TIMER MOTOR**

B. During the water filling operation, check to see that the incoming water dribblers, through the evaporator platen dribbler holes, down into the sump reservoir to fill it up and also that the incoming surplus of water flows out through the overflow pipe into the drain line.

NOTE. If, in the defrost cycle length, the machine sump reservoir does not get filled with water up to the rim of the overflow pipe, remove the front panel and rotate the shaft of the timer so to cause the dropping of the two microswitches actuators into the beginning of the cam slot and check for:

1. The water pressure of the water supply line, it must be at least **1 bar (14 psig)** Minimum (Max 5 bar-70 psig).
2. The filtering device installed in the water line that may reduce the water pressure below the Minimum value of 1 bar (14 psig).
3. Any clogging situation in the water circuit like the inlet water strainer and/or the flow control.

OPERATIONAL CHECKS

C. At completion of the water filling phase the unit initiate automatically the first freezing cycle with the start up of (Fig.1):

COMPRESSOR

CONTACTOR COIL (SMN 75-125)

WATER PUMP

FAN MOTOR (in air cooled version)

D. Check to see through the ice discharge opening that the spray system is correctly seated and that the water jets uniformly reach the interior of the inverted mold cups or the exterior of the evaporator tips; also make sure that the plastic curtain is hanging freely and there is not excessive water spilling through it.

E. The ice making process takes place thereby, with the water sprayed into the molds or onto the tips that gets gradually refrigerated by the heat exchange with the refrigerant flowing into the evaporator serpentine. During the first portion of the freezing cycle, the timer assy is standing-by with its microswitches actuators resting on the raised cam profile (position that correspond to the end of the defrost cycle).

F. Then, as the cube size control cut-in point is reached by the evaporator temperature the control of the cycle is passed to the timer assy. Whose raised cam slowly rotates to continue the freezing cycle (2nd phase) up to its completion. The components in operation during this 2nd phase of the cycle are:

- COMPRESSOR**
- CONTACTOR COIL (SMN 75-125)**
- WATER PUMP**
- FAN MOTOR (in air cooled version)**
- TIMER MOTOR**

G. After about 18 ÷20 minutes from the beginning of the freezing cycle, in an hypothetic ambient temperature of 21°C, the defrost cycle takes place with the hot gas and the water inlet valves being simultaneously activated. The electrical components in operation are:

- COMPRESSOR**
- CONTACTOR COIL (SMN 75-125)**
- WATER INLET SOLENOID VALVE**
- HOT GAS VALVE**
- TIMER MOTOR**
- FAN MOTOR (only SMN 35) air cooled**

H. Check, during the defrost cycle, that the incoming water flows correctly into the sump reservoir in order to refill it and that the surplus overflows through the overflow drain tube.

I. Check the texture of ice cubes just released. They have to be of the right size with a thickness of about 7÷8 mm. If the ice cubes have not the correct size, wait for a second harvest before attempting any adjustment by setting the cube size control.

By rotating the control setting screw clockwise the ice cube thickness can be increased; on the contrary the thickness can be reduced by turning the setting screw counterclockwise.

If the ice cubes are shallow and cloudy, it is possible that the ice maker runs short of water during the freezing cycle second phase or, the quality of the supplied water requires the use of an appropriate water filter or conditioner.

- J. With the icemaker in the harvest cycle, hold ice against the bin thermostat control bulb to test its shut off. This should cause the ice maker to shut OFF after 30 seconds, 1 minute at the most, namely when the control bulb temperature drops to reach $+1^{\circ}\text{C}$.

NOTE. In case this test is performed during the freezing cycle, the unit will shut OFF only at the end of the freezing cycle.

Within minutes after the ice is removed from the sensing bulb, the bulb will warm up to reach $+4^{\circ}\text{C}$ and consequently will cause the icemaker to restart from the harvest (defrost) cycle.

- K. Instruct the owner/user on the general operation of the ice machine and about the cleaning and care it requires.

PRINCIPLE OF OPERATION

In the **SIMAG** cube ice makers the water used to make the ice is kept constantly in circulation by an electric water pump which primes it to the spray system nozzles from where it is diverted into the molds of the evaporator. A small quantity of the sprayed water freezes into ice; the rest of it cascades by gravity into the sump assembly below for recirculation.

FREEZING CYCLE

The hot gas refrigerant discharged out from the compressor reaches the condenser where, being cooled down, condenses into liquid. Flowing into the liquid line it passes through the drier filter, then it goes all the way through the capillary tube where, due to the heat exchanging action, it loses some of its heat content so that its pressure and temperature are lowered as well.

Next the refrigerant enters into the evaporator serpentine (which has a larger I.D. than the capillary) and starts to boil off; this reaction is emphasized by the heat transferred by the sprayed water.

The refrigerant then increases in volume and changes entirely into vapor.

The vapor refrigerant then passes through the suction accumulator (used to prevent that any small amount of liquid refrigerant may reach the compressor) and through the suction line. In both the accumulator and the suction line it exchanges heat with the refrigerant flowing into the capillary tube (warmer), before to be sucked in the compressor and to be recirculated as hot compressed refrigerant gas.

The freezing cycle is controlled by the evaporator thermostat (which has its bulb in contact with the evaporator serpentine) that determines the length of its first portion of the cycle.

When the temperature of the evaporator thermostat bulb drops to a pre-set value, the evaporator thermostat changes its contacts (from 3-4 to 3-2) supplying power to the finishing timer that takes the control of the second timed portion of the freezing cycle up to its completion.

The length of this second timed portion of the freezing cycle is pre-fixed.

The electrical components in operation during the freezing cycle are:

COMPRESSOR

CONTACTOR COIL (SMN 75-125)

FAN MOTOR (in air cooled version)

WATER PUMP

and during the second phase of freezing cycle (Time mode) they are joined by the

TIMER

On the SMN 45, SM75, SMN125 air cooled the refrigerant head pressure, in the course of the freezing cycle, ranges between 8-10 bars SMN 45, 8÷9,5 bars SMN75 and 15,5÷20 bars SMN 125 being controlled by the hi-pressure control.

When the discharge pressure rises up to a pre set value, the pressure control closes its electrical contacts supplying power to the **FAN MOTOR**.

As soon as the discharged refrigerant pressure drops, the pressure control opens its contacts to temporarily de-energize the fan motor. On others air cooled models (SMN 35) the fan motor is constantly activated and retain the head pressure between 8÷10 bars (110÷140 psig).

On the models from SMN 35÷45 water cooled version the same hi-pressure control is used to intermittently energize a water solenoid valve located on the water supply line to the condenser. On the other models SMN75-125, in water cooled version, the discharge pressure is kept constant by the water regulating valve that meters the water flow to the condenser.

NOTE. In case of shortage/insufficient cooling water or air condenser dirty, the operation of the **safety device by hand reset** will stop the machine as soon as the temperature reach 70/75 °C (160/170 °F) or the corresponding pressure. After eliminated the cause of the stop, **put the machine in operation by pushing the reset button of the safety thermostat or pressure switch** across the holes in the down/right side of the front panel or removing it.

At the start of the freezing cycle the refrigerant suction or lo-pressure lowers rapidly to **0,8 bars (11 psig)** SMN 35÷SMN75, **3,6 bars (50 psig)** SMN125 then it declines gradually - in relation with the growing of the ice thickness - to reach, at the end of the cycle, approx. **0,1 bars (1,4 psig)** SMN 35÷SMN75, **1,5 bars (21 psig)** SMN 125

with the cubes fully formed in the cup molds.

The total length of the freezing cycle ranges from 18 to 20 minutes.

DEFROST OR HARVEST CYCLE

As the electric timer has carried the system throughout the second phase of freezing cycle, the defrost cycle starts.

NOTE. The length of the defrost cycle is pre-determined by the setting of timer

o

In case it is possible to modify the defrost cycle length through its trimer

ATTENTION. The defrost period is the most critical for the icemaker main components especially the compressor. To avoid to abuse of them it is strongly recommended to limit the harvest cycle extension to 4 minutes at the most.

The electrical components in operation during this phase are:

COMPRESSOR

- CONTACTOR COIL** (SMN 75-125)
- FAN MOTOR** (only SMN 35) air cooled
- WATER INLET SOLENOID VALVE**
- HOT GAS SOLENOID VALVE**
- TIMER MOTOR**

The incoming water, passing through the water inlet valve and in its incorporated flow control (outlet), runs over the evaporator platen and then flows by gravity through the dribbler holes down into the sump/reservoir.

The water filling the sump/reservoir forces part of the left-over water from the previous batch to run out to the waste through the overflow pipe. This overflow limits the level of the sump water which will be used to produce the next batch of ice cubes.

Meanwhile, the refrigerant as hot gas, discharged from the compressor, flows through the hot gas valve directly into the evaporator serpentine by-passing the condenser.

The hot gas circulating into the serpentine of the evaporator warms up the copper molds or the tips causing the defrost of the ice cubes. The ice cubes, released from the molds, drop by gravity onto a slanted grid chute, then through a curtained opening they fall into the storage bin.

At the end of the defrost cycle, both the hot gas and the water inlet valves close and the machine starts again a new freezing cycle.

OPERATION - CONTROL SEQUENCE

At the start of freezing cycle, the evaporator **thermostat** controls the length of the first part of the freezing cycle. As its bulb senses a predetermined temperature, it closes its contacts to supply power to the **timer motor** which, in turn, takes over the control of the freezing cycle. This second part of the cycle has a pre-fixed time duration of 12 minutes.

NOTE. The evaporator thermostat is factory set to the number 4 of its setting dial.
 In case it is required the setting of the evaporator thermostat can be made by turning its adjusting screw located on front side.
 With a clockwise rotation of the setting screw the thermostat cut IN temperature will be lowered (longer freezing cycle - thicker ice cube) while, with a counterclockwise rotation of the screw, the Cut IN temperature rises (shorter freezing cycle - thinner ice cube).

Once completed the freezing cycle 2nd phase the system switches automatically into the defrost cycle which has a pre-fixed length as well. At completion of the defrost period the unit starts again a new freezing cycle.

OPERATION - ELECTRICAL SEQUENCE

The following charts illustrate which switches and which components are ON or OFF during a particular phase of the icemaking cycle. Refer to the wiring diagram for a reference.

NOTE. The wiring diagram shows the unit as it is in the Evaporator Thermostat mode of the Freezing Cycle.

BEGINNING FREEZE

Electrical components (Loads)	ON	OFF
Compressor	•	
Fan motor	•	
Hot gas valve		•
Water inlet valve		•
Water pump	•	
Contact coil	•	
Timer motor		•

Electric Controls	ON	OFF
Conctats 3-4 evaporator thermostat ..	•	
Conctats 3-2 evaporator thermostat ..		•
Bin thermostat	•	
Conctats timer	•	
Conctats timer		•
Pressure control (SMN35÷45W) (SMN45÷SM125A)		•

TIMED FREEZE

Electrical components (Loads)	ON	OFF
Compressor	•	
Fan motor	•	•
Hot gas valve		•
Water inlet valve		•
Water pump	•	
Contact coil	•	
Timer motor	•	

Electric Controls	ON	OFF
Conctats 3-4 evaporator thermostat ..		•
Conctats 3-2 evaporator thermostat ..	•	
Bin thermostat	•	
Conctats timer	•	
Conctats timer		•
Pressure control (SMN35÷45W) (SMN45÷SMN125A)	•	•

1° PORTION HARVEST CYCLE

Electrical components (Loads)	ON	OFF
Compressor	•	
Fan motor (SMN 35 ON)		•
Hot gas valve	•	
Water inlet valve	•	
Water pump		•
Contact coil	•	
Timer motor		•

Electric Controls	ON	OFF
Conctats 3-4 evaporator thermostat ..		•
Conctats 3-2 evaporator thermostat ..	•	
Bin thermostat	•	
Conctats timer		•
Conctats timer	•	
Pressure control (SMN35÷45W) (SMN45÷SM125A)		•

II° PORTION HARVEST CYCLE

Electrical components (Loads)	ON	OFF
Compressor	•	
Fan motor (SMN 35 ON)		•
Hot gas valve	•	
Water inlet valve	•	
Water pump		•
Contacteur coil	•	
Timer motor	•	
Electric Controls		
Conctats 3-4 evaporator thermostat ..	•	
Conctats 3-2 evaporator thermostat ..		•
Bin thermostat	•	
Conctats timer		•
Conctats timer	•	
Pressure control (SMN35÷45W) (SMN45÷SM125A)		•

OPERATING CHARACTERISTICS

On air cooled models during the freezing cycle the discharge pressure is kept between 8 ÷10 bars (110÷140 psig) SMN35÷SMN75, 15,5÷20 bars (215÷280 psig) SMN125.

At the same time the suction pressure will gradually decline, reaching its lowest point just before harvest. Compressor amps experience a similar drop.

COMPONENTS DESCRIPTION

A. MASTER SWITCH

Fitted on the front side of the unit cabinet the master switch has to be used to start-up and to stop the ice maker operation. In connection with it there is the green monitor light.

B. EVAPORATOR THERMOSTAT

The evaporator thermostat with its sensing bulb intimately in contact with the refrigerant outlet tube from the evaporator, senses the evaporating refrigerant temperature (which declines in the course of the freezing cycle) and when this one reaches the pre-set value, it switches its contacts from 3-4 to 3-2 to activate the finishing cycle (2nd phase) which has a pre-set extension determined by the large diameter lobe of the timer cam.

C. BIN THERMOSTAT

The bin thermostat, which has its sensing bulb downward into the storage bin, shuts-OFF automatically the icemaker when the ice storage bin is filled and ice contacts its bulb. Being it connected in series with the front microswitch of the timer, it causes the unit shut-off only at the end of the freezing cycle, when the ice cubes are completed.

After ice is removed from the bin and its bulb warm-up it allows the unit to restart from the beginning of the harvest cycle which, in the circumstance, is more likely a water filling cycle.

D. TIMER

Equipped with two DIP switch and a Potentiometer. it is located inside the control box.

The function of the timer begins when activated by the cube size control (evap. thermostat).

Potentiometer used to adjust the defrost time from 60" min to 180" max.

WARNING. Never set the defrost time for longer than 4 minutes as this will jeopardize the compressor motor windings.

Consequently any variation made at the timer requires a compensation adjustment, very fine and very accurate, of the evaporator thermostat.

E. COMPRESSOR DIP SWITCH

The compressor DIP switch is located on the Timer of the control box and it can be switched in two different positions which are:

Operation Supply power directly to the compressor motor or, on models SMN75, SMN125, directly to the contactor coil.

Cleaning Shuts-off the compressor so that only the water pump and the water inlet valve will remain in operation.

When positioned on "0 - OFF" the water pump primes the cleaning or the bactericide solution all over the unit water system to generate a good cleaning and sanitizing action of the ice maker.

NOTE. It is recommended to avoid the rinsing, after the sanitation of the unit water system, as any bactericide coating, which is beneficial to limit the bacteria growth, left-over in the system may be removed.

F. HI PRESSURE CONTROL

Used either on air (SMN45-SMN75-125A) and water (SMN35÷45W) cooled ice makers it functions to maintain the head pressure within the preset values of 8 ÷10 bars (110÷140 psig) SMN35÷SMN75, and 15,5÷20 bars (215÷280 psig) SMN125, by intermittently activating the fan motor (in the air cooled models) and the water inlet valve to the condenser (in the water cooled models SMN 35-45).

G. SAFETY THERMOSTAT/PRESSURE SWITCH (BY HAND RESET)

Fastened directly onto the refrigerant liquid line and electrically connected upstream all other controls, this safety device shut-off the icemakers when senses that the temperature at the liquid line has risen to the limit of 75 °C (170°F) or corresponding pressure.

H. WATER SPRAY SYSTEM

It consists of one spray bar with several spray nozzles on its extension. The water pumped, is sprayed through its nozzles in each individual mold or onto each evaporator tip to be frozen into ice.

I. WATER PUMP

The water pump operates continually throughout the freezing cycle. The pump primes the water from the sump to the spray system and through the spray nozzles sprays it to the copper molds or onto the evaporator tips to be frozen into crystal clear ice cubes. It is recommended that the pump motor bearings be checked at least every six months.

J. WATER INLET SOLENOID VALVE - 3/4 MALE FITTING

The water inlet solenoid valve is activated by the timer microswitch only during the defrost cycle. When energized it allows a metered amount of incoming water to flow over the evaporator cavity to assist the hot gas in defrosting the ice cubes. The water running over the evaporator cavity drops by gravity, through the dribbler holes of the platen, into the sump reservoir where it will be sucked by the water pump and primed to the spray system.

K. HOT GAS SOLENOID VALVE

The hot gas solenoid valve consists basically in two parts: the valve body and the valve coil. Located on the hot gas line, this valve is energized through the timer microswitch contacts COM-NC during the defrost cycle. During the defrost cycle the hot gas valve coil is activated so to attract the hot gas valve piston in order to give way to the hot gas discharged from compressor to flow directly into the evaporator serpentine to defrost the formed ice cubes.

L. FAN MOTOR (Air cooled version)

The fan motor, in the SMN45-SMN-75-125 models is electrically connected in series with the pressure control operates during the freezing cycle to draw cooling air through the condenser fins so to keep the condensing pressure between the two preset values 8÷10 bars (110÷140 psig) SMN 75 and 15,5÷20 bars (215÷280 psig) SMN125

In the other models SMN35-45 the fan motor works continuously in order to maintain the condensing pressure between 8 ÷10 bars (110÷140 psig).

M. WATER INLET SOLENOID VALVE - 3/4 MALE FITTING (SMN 35 ÷45 water cooled version)

A second water inlet solenoid valve, operating through an automatic hi-pressure control, is used on water cooled versions to supply water to the condenser. When activated it supplies a metered amount of water to the condenser in order to limit its temperature and the refrigerant operating high pressure.

N. WATER REGULATING VALVE (Water cooled version SMN75 ÷ 125)

This valve controls the head pressure in the refrigerant system by regulating the flow of water going to the condenser. As pressure increases, the water regulating valve opens to increase the flow of cooling water.

O. COMPRESSOR

The hermetic compressor is the heart of the refrigerant system and it is used to circulate and retrieve the refrigerant throughout the entire system. It compresses the low pressure refrigerant vapor causing its temperature to rise and become high pressure hot vapor which is then released through the discharge valve.

P. CONTACTOR (SMN 75-125 only)

Placed inside the control box it operates in order to close or open the electrical circuit to the compressor.

SERVICE DIAGNOSIS

SYMPTOM	POSSIBLE CAUSE	SUGGESTED CORRECTION
Unit will not run	Main switch in OFF position Safety device intervention (thermostat - pressure switch) Loose electrical connections Inoperative bin thermostat	Turn switch to ON position Eliminate the stop motivation and push the reset button or replace. Check wiring Replace thermostat
Compressor cycles intermittently	Low voltage Contactor with burnt contacts Non-condensable gas in system Compressor starting device with loose wires To high room temperature	Check circuit for overloading Check voltage at the supply to the building. If low, contact the power company Clean or replace Purge the system Check for loose wires in starting device Move the unit in a more suitable place
Cubes too small	Freezing cycle too short Capillary tube partially restricted Moisture in the system Shortage of water Shortage of refrigerant Inoperative evaporator thermostat	Review setting Blow charge, add new gas & drier, after evacuating system with vacuum pump Same as above See remedies for shortage of water Check for leaks & recharge Replace thermostat
Cloudy cubes	Shortage of water Dirty water supply Accumulated impurities cleaner Water pump losing disch. pressure	See remedies for shortage of water Use water softener or water filter Use Ice Machine Cleaner Check bearings. Replace.
Shortage of water	Water spilling out through curtain Water solenoid valve not opening Water leak in sump area Water flow control plugged	Check or replace curtain Replace valve Locate and repair Remove and clean

SERVICE DIAGNOSIS

SYMPTOM	POSSIBLE CAUSE	SUGGESTED CORRECTION
Irregular cubes size & some cloudy	Some jets plugged Shortage of water Unit not level	Remove jet cover and clean See shortage of water Level as required
Cubes too large	Freezing cycle too long Inoperative evaporator thermostat	Adjust evap. thermostat Replace thermostat
Decreased ice capacity	Inefficient compressor Leaky water valve Non-condensable gas in system Poor air circulation or excessive hot location (Red-alarm LED glows) Overcharge of refrigerant Capillary tube partially restricted Hot gas solenoid valve leaking Undercharge of refrigerant Discharge head pressure too high	Replace Repair or replace Purge the system Relocate the unit or provide for more ventilation Correct the charge. Purge off slowly Blow charge, add new gas & drier, after evacuating system with vacuu pump Replace valve Charge to data plate indication See incorrect discharge pressure
Poor harvest	Restriction in incoming water line Water inlet valve not opening Hot gas valve orifice restricted Discharge head pressure too low	Check water valve strainer and flow control. If necessary enlarge the flow control orifice Valve coil with open winding Replace valve Replace hot gas valve assy See incorrect discharge pressure
Incorrect discharge pressure	Inoperative fan pressure control Inoperative fan motor Water regulating valve misadjusted	Replace pressostat Replace Adjust its setting stem
Excessive water in unit base	Water tubing leaking	Check. Tighten or replace

MAINTENANCE AND CLEANING INSTRUCTIONS

A. GENERAL

The periods and the procedures for maintenance and cleaning are given as guides and are not to be construed as absolute or invariable. Cleaning, especially, will vary depending upon local water and ambient conditions and the ice volume produced; and, each icemaker must be maintained individually, in accordance with its particular location requirements.

B. ICEMAKER

The following maintenance should be scheduled at least two times per year on these icemakers, by using the SIMAG technical service.

1. Check and clean the water line strainer.
2. Check that the icemaker is levelled in side to side and in front to rear directions.
3. Clean the water system, evaporator, bin and spray jets using a solution of Ice Machine Cleaner.

Refer to procedure C cleaning instructions and after cleaning will indicate frequency and procedure to be followed in local areas.

NOTE. *Cleaning requirements vary according to the local water conditions and individual user operation. Continuous check of the clarity of ice cubes and visual inspection of the waterspraying parts before and after cleaning will indicate frequency and procedure to be followed in local areas.*

4. With the ice machine and fan motor OFF on aircooled models, clean condenser using vacuum cleaner, whisk broom or non metallic brush taking care to do not damage both the condenser and ambient temperature sensors.
5. Check for water leaks and tighten drain line connections. Pour water down bin drain line to be sure that drain line is open and clear.
6. Check size, condition and texture of ice cubes. Perform adjustment of the evaporator thermostat or cube size control by turning its adjusting screw clockwise for a thicker ice cube and counterclockwise for a thinner one.
7. Check the bin thermostat to test shut-off. Put a handful of ice cubes in contact with its bulb. This should cause the ice maker to shut off within 20÷30", but only at the end of the freezing cycle!

NOTE. *Perform the above check only at the beginning of the harvest cycle as, during the freezing cycle the bin thermostat contacts are bypassed by the front microswitch of the timer.*

When remove the ice cubes from its sensing bulb the unit will restart after few seconds from the defrost cycle assuring the filling up of the water tank.

NOTE. *It is possible to adjust the setting temperature of the bin thermostat by slightly turning its adjusting screw.*

8. Check for refrigerant leaks.

C. CLEAN - REPLACE OF AIR CONDENSER FILTER

1. Withdraw the air filter from the front through the opening of the front panel.



2. Blow pressurised air on the opposite direction of the condenser air flow so to remove the dust accumulated.
3. If pressurised air is not available, use tap water always in the counter flow air direction. Once cleaned shake it so to remove most of the accumulated water, then dry it using an hair dryer.

NOTE. *In case the air filter strainer is damaged replace it with a new one.*

4. Install it again by pushing it through the front panel opening.

D. CLEANING INSTRUCTIONS OF WATER SYSTEM

1. Remove the front and the top panels to gain access either to the control box and to the evaporator.

2. Wait till the end of defrost cycle then, shut the unit OFF by means of its master switch.
3. Scoop out all the ice cubes stored into the bin in order to prevent them from being contaminated with the cleaning solution then flush out the water from the sump reservoir by removing the overflow stand-pipe.
4. Remove the plastic cup located on the bottom of sump/freezing chamber to drain out all water and scale deposits.



5. Prepare the cleaning solution by diluting in a plastic container two or three liters of warm water (45°÷50°C) with a 0,2 ÷0,3 liters of Ice Machine Cleaner PIN 00100901.

WARNING. The Ice Machine Cleaner contains Phosphoric and Hydroxyacetic acids. These compounds are corrosive and may cause burns if swallowed, DO NOT induce vomiting. Give large amounts of water or milk. Call Physician immediately. In case of external contact flush with water. KEEP OUT OF THE REACH OF CHILDREN

6. Remove the evaporator cover then slowly pour onto the evaporator platen the cleaning solution. With the help of a brush dissolve the most resistant and remote scale deposits in the platen.
7. Set the compressor switch on "**0 - OFF**" position and give power to the unit by the master switch (Fig.6).

NOTE. With the system in **CLEANING** mode the water pump is the only component in operation to circulate the cleaning solution in the entire water system.

8. Let the unit to remain in the **CLEANING** mode for about 20 minutes then switch OFF the machine.
9. Flush out the cleaning solution from the sump reservoir then pour onto the evaporator cavity one or two liters of clean potable water with the antibacteria solution P/N 26400002 to rinse and sanitize the molds and the spray system. If necessary remove the spary bar and nozzles to clean them separately then refit them.
10. Set back the master switch to ON. The water pump is again in operation to circulate the water and the antibacterial solution in order to rinse the entire water system. Switch OFF the unit after approx. 10 minutes and flush out the rinsing water from the sump reservoir.
11. To rotate the timer so that the microswitches reach the beginning of the defrost cycle (low part of the cam) give power to the unit by the master switch. By doing so are energized the water pump and the water inlet valve. In this way the incoming water flow away to fill up the water tank.
12. When the water tank is filled up (water flowing out from the drain) put the compressor switch on **ION** position to restart the machine in the automatic mode.

13. Re-fit the evaporator cover and the unit service panels.

14. At completion of the freezing and harvest cycle make sure of proper texture and clearness of the ice cubes and that, they do not have any acid taste.

ATTENTION. In case the ice cubes are cloudy, white and have an acid taste, melt them immediately by pouring on them some warm water. This to prevent somebody from using them.

15. Wipe clean and rinse the inner surfaces of the storage bin.

REMEMBER. To prevent the accumulation of undesirable bacteria it is necessary to **sanitize the interior of the storage bin** with an anti-algae disinfectant solution **every week.**