



CATERING EQUIPMENT

Heated Display Case

OPERATION INSTRUCTIONS



7487.0135



7487.0140

Thank you for choosing and purchasing our product. Please carefully read the operation instructions before use for a correct application and satisfactory effect.

Contents

- 2. General**
- 2. Structure and Parts**
- 2. Safety**
- 3. Preparation and Power Supply**
- 3. Installation and operation**
- 4. Maintenance and cleaning**
- 5. Cautions**
- 5. Major Parameters**
- 5. Electric Circuit Diagram**

General

1. This instruction manual contains information about the installation, operation and maintenance of the device and should be consulted as an important source of information and reference guide.
2. Awareness of the safety instructions and instructions for use in this manual will ensure the safe and correct use of the device.



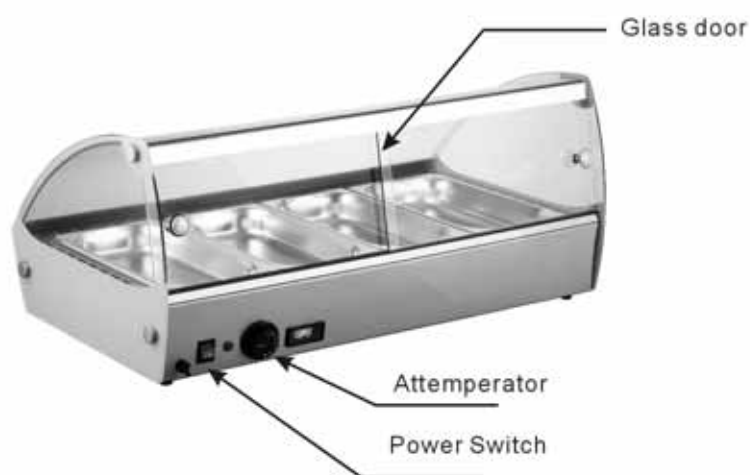

Structure and Parts

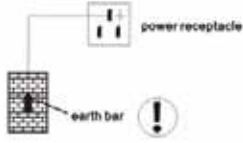

Safety

- ※ To prevent hazards and to ensure optimum efficiency, no modifications or alterations to the device that are not explicitly approved by the manufacturer may be undertaken.
This device may only be operated in technically proper and safe condition.
- ※ The device should be never left unattended during operation. Keep away children.
- ※ Preserve this manual safely. When passing on/selling the device to a third party, the manuals must be handed over along with the device.
- ※ Every person using the device must act in accordance to the manuals and under consideration of the safety advice.
- ※ The device is to be used indoors only.
- ※ Any technical interventions, as well as assembly and maintenance are to be made by a qualified customer service only.
- ※ This appliance is not intended for use by persons (including children) with reduced physical, sensory or mental capabilities, or lack of experience and knowledge, unless they have been given supervision or instruction concerning use of the appliance by a person responsible for their safety.
- ※ Children should be supervised to ensure that they do not play with the appliance
- ※ The operation manual is not suitable for the persons (including children) with reduced physical, sensory or mental capabilities, or lack of experience and knowledge.

Preparation and Power Supply

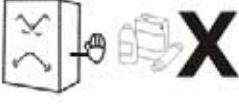
<p>Exclusive power socket The power receptacle must have a reliable earth connection.</p>  <p>The diagram shows a power receptacle with three slots. A line connects it to an earth bar, which is a rectangular block with a vertical rod protruding from its center. A warning symbol (exclamation mark inside a circle) is placed next to the earth bar.</p>	<p>No share on socket Never let the device share the common socket with other appliance, otherwise the cable becomes hot and fire might be resulted</p>  <p>The diagram shows a power strip with two outlets. A hand is shown plugging a cord into one of the outlets. A warning symbol (exclamation mark inside a circle) is placed next to the power strip.</p>
<p>Protect cables Never break or damage the cables otherwise current leakage and fire might be resulted.</p>  <p>The diagram shows a hand using a knife to cut a power cable. A large 'X' is placed over the scene to indicate that this action is prohibited.</p>	<p>No water flushing Never give the device surface a flush otherwise current leakage might be resulted.</p>  <p>The diagram shows a hand spraying water from a nozzle onto a device. A large 'X' is placed over the scene to indicate that this action is prohibited.</p>
<p>Prevent from flammables and explosive Never put any flammable or explosive inside the device such as ether, gasoline, alcohol, adhesive and explosive. Never put dangerous product nearby the device .</p>  <p>The diagram shows a hand pouring liquid from a bottle into a device. A large 'X' is placed over the scene to indicate that this action is prohibited.</p>	

Installation and Operation

Installation

- * Place the device on top of an even and safe surface which supports the weight of the device and is not heat sensitive.
- * Not at any time should you place the device on an inflammable surface (such as table cloth, carpet, etc)
- * You must no position the device near open fireplaces, electric ovens/arc furnaces/electric heaters or other heat sources.
- * Position the device in such a way that the plug is easily accessible.

Operation

- ※ Before first use, clean the inner sides and the playing grids with a soft cloth and a mild cleaning agent. Afterwards, dry the device thoroughly.
- ※ Remove the water bowl from the device. The water bowl is installed inside the device and then fill the water bowl with water.
- ※ Connect the device to a single grounded power socket.
- ※ Set the temperature as required for respective foods. You may adjust the desired temperature in the range between 30°C-90°C.
- ※ The temperature inside of the hot display can be read from the front display.
- ※ Put the foods in appropriate containers before playing them inside the hot display and shut it by using the sliding door.
- ※ Some of the device parts become very hot, always use safety gloves when placing or removing foods.
- ※ The foods are kept warm at the temperature set by you previously.
- ※ In order to place or remove foods, you may open the door at rear side.
- ※ Switch on the inner light when required using the light switch of the device.
- ※ Disconnect the device from the power socket when the device is not in use.

Cleaning and Maintenance

- ※ Before beginning with repair or cleaning works make sure the device has been disconnected from the power socket and has cooled down.
- ※ Don't use any acid agents and make sure no water ingresses the device.
- ※ To protect yourself from the electric shock, never immerse the device, its cables and the plug in water or other liquids.
- ※ Don't use any kind of pressure water jet for cleaning the device.

Cleaning

- ※ The device should be cleaned regularly.
- ※ Clean the device from the inside and outside with a soft, damp cloth and a mild cleaning agent.
- ※ Clean the placing grids and the housing with a soft, damp cloth and a mild cleaning agent.
- ※ Clean the water bowl regularly. Calcifications at the water bowl may be removed with common agents or liquids.
- ※ Only use a soft cloth and make sure you never use any kind of abrasive agents or pads which could scratch the surface.
- ※ After the cleaning procedure, you should use a soft and dry cloth to wipe dry and polish the surface.
- ※ Make sure the device has been cleaned properly before storing it in a dry place.

Maintenance

- ※ Check the mains lead from time to time to ensure it is not damaged in any way. Never use the device if the lead is damaged. If the lead is damaged, it must be replaced by a qualified electrician.
- ※ Only a qualified technician should carry out repairs and maintenance of the device. Do not attempt to repair the device by yourself.

Cautions

Children should be supervised to ensure that they do not play with the appliance.

- If the supply cord is damaged, it must be replaced by the manufacturer, its service agent or similarly qualified persons in order to avoid a hazard.

Major Parameters

Parameter \ Model	7487.0135	7487.0140		
Temperature range(°C)	30-90	30-90		
General Rated Input Power(W)	500	800		
Rated Current (A)	2.2	3.5		
Rated Voltage(V)	220-240~	220-240~		
Rated Frequency(Hz)	50	50		
Storage Volume(L)	46	68		
Net Weight(kg)	16	22		
Grade of Waterproof	IPX4	IPX4		
Overall Dimension(mm)	773x420x336	1127x420x336		

Circuit Diagram

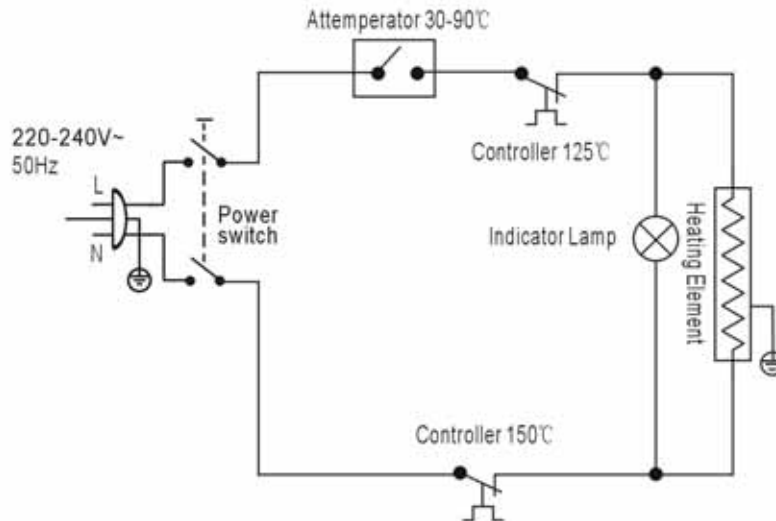

Note

1. The electric circuit diagram and parameters on the product name plate are final ones if they have been changed.
2. The design might be improved without notice.



Meaning of crossed out wheeled dustbin:

Do not dispose of electrical appliances as unsorted municipal waste, use separate collection facilities. Contact you local government for information regarding the collection systems available.

If electrical appliances are disposed of in landfills or dumps, hazardous substances can leak into the groundwater and get into the food chain, damaging your health and well-being.

When replacing old appliances with new ones, the retailer is legally obligated to take back your old appliance for disposals at least free of charge.



Caution hot surface